

ApenGroup®



Industrial Heating and Conditioning

AX SERIES

WATER FAN HEATERS



NEW

CONTROLLER
OPTIONAL



SMART CONTROLS
OPTIONAL



ELECTRONIC
FAN HEATERS



CLASS
A

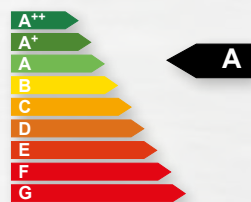

AX SERIES

Water fan heaters

WATER FAN HEATERS, AVAILABLE IN STANDARD AND ELECTRONIC VERSIONS

The AX SERIES water fan heaters are a line of modern and reliable products designed for heating many different facilities: from industrial plants to the tertiary sector, from sports facilities to commercial sectors.

AX SERIES AND AX-EC SERIES

Fan heaters are available in two configurations:

- AX: fan heater with 1-speed fan and 5-speed selector (to be ordered as optional)
- AX-EC: fan heater with electronic fan

SECTORS OF USE

- Facilities
- Sheds
- Body shops
- Workshops with all types of processing
- Carpenter's workshops
- Shopping malls
- Public environments
- Data Processing Centres
- Theatres and Conference Centres
- Exhibition and Dancing Rooms
- Tanneries
- Pools and Gyms
- Churches and Oratories

SIMPLE INSTALLATION

Its particularly small size and weight make it easy to move and position. Installation is limited to fixing by means of practical coupling and support systems.

ADAPTABILITY

The water fan heaters can be combined with:

- AKN system
- AquaPump Hybrid
- Thermal station
- Water heat pumps
- Cascade boiler modules
- Floor-standing boilers

POSITIONING VERSATILITY

The water fan heaters can be either wall-mounted or fastened to the ceiling (for heating only) with the air directed downwards.

SYSTEM MODULARITY

The subdivision of the total heat output over several installed water fan heaters makes it possible to achieve greater rationalisation of the system: "zone" management of the heat output.

WATER FAN HEATERS IN COOLING MODE

It is possible to set the water fan heaters to operate in cooling mode by activating ventilation, thus improving the comfort of the room in which they are installed. The water fan heaters are designed to house a condensate collection tray, which can be fitted at any time, even after wall installation.

MODERN AND ESSENTIAL DESIGN

The water fan heaters have been designed with particular attention to line and design.

AX SERIES WATER FAN HEATERS

TECHNICAL FEATURES

- Available in 7 models with power from 18 kW to 90 kW
- High-efficiency one, two or three-row finned exchange battery
- Automatic air vent valve
- Louvres with adjustable horizontal blades
- 230V/1/50Hz power supply
- IP25B Protection degree
- Rotatable shelf as standard
- Configuration for a condensate collection tray (optional) for use in cooling mode
- Casing made of ABS material.

ACCESSORIES UPON REQUEST

Remote control in IP54 complete with SUMMER/O/ WINTER button and switch to select the 5 speeds.



COMPONENTS

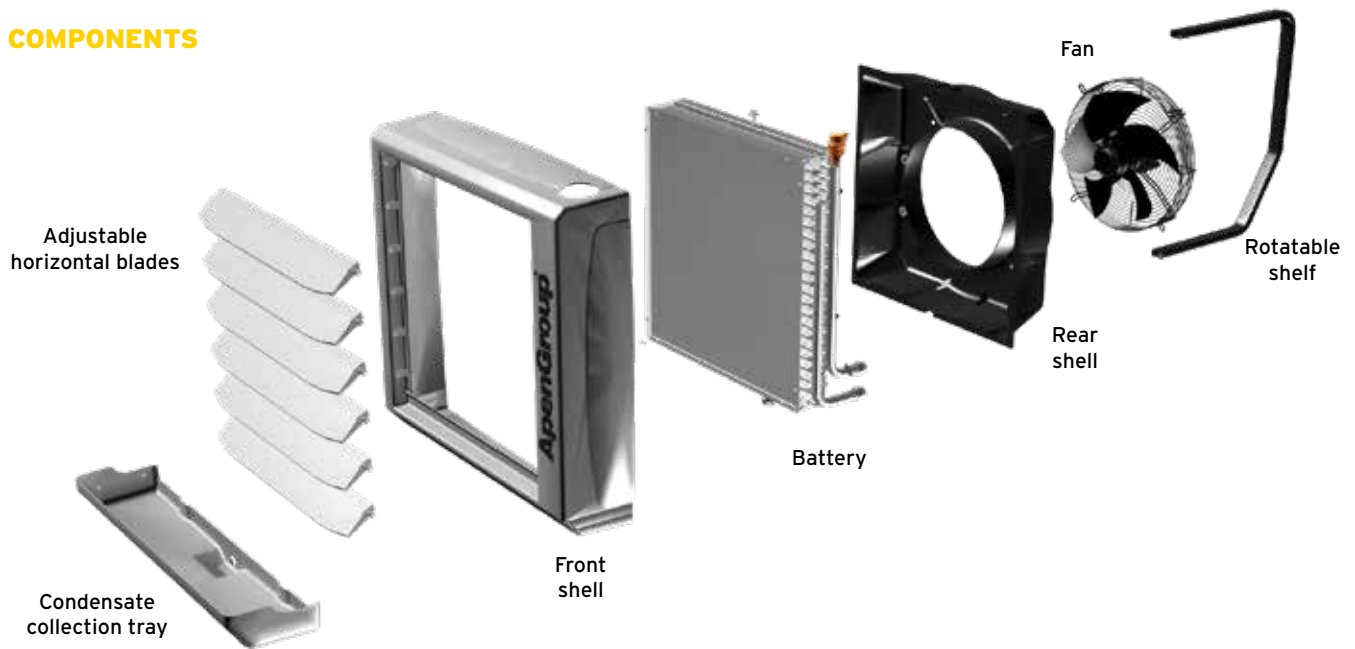

INSTALLATION HEIGHT

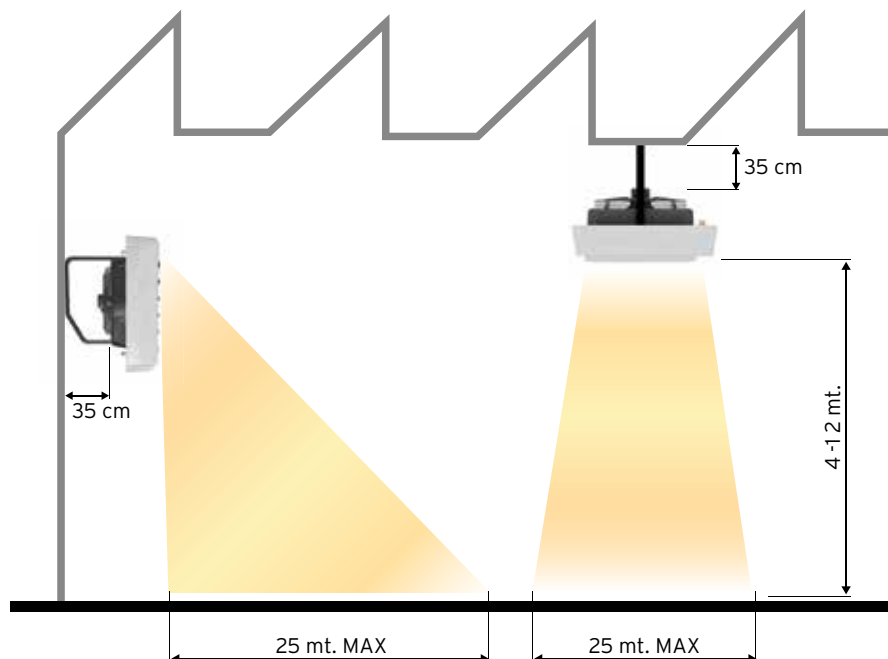

AX-EC SERIES ELECTRONIC WATER FAN HEATERS

TECHNICAL FEATURES

- Available in 7 models with power from 18 kW to 90 kW
- High-efficiency one, two or three-row finned exchange battery
- Electronic fans with integrated inverter
- Automatic air vent valve
- Louvres with adjustable horizontal blades
- 230V/1/50Hz power supply
- IP25B Protection degree
- Switch-on, switch-off and air flow rate regulation with 0-10 Vdc signal
- Rotatable shelf as standard
- Configuration for a condensate collection tray (optional) for use in cooling mode
- Casing made of ABS material.

ACCESSORIES UPON REQUEST

- KIT G24500:
- SmartWeb
 - CPU electronic board
 - Immersion probe to be connected to CPU
 - Room probe
 - Control panel



POSSIBLE CONFIGURATIONS



**AX-EC
WATER FAN HEATER**



**STAND
ALONE**

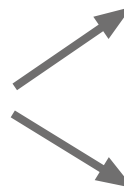

**CONTROLLABLE WITH
0-10 VOLT SIGNAL**

**KIT G03780
POTENTIOMETER
MANUAL REMOTE CONTROL**



**AX-EC
WATER FAN HEATER**



G24500 KIT COMPOSED BY:

- SmartWeb
- CPU electronic board
- Immersion probe to be connected to CPU
- Room probe
- Control panel



SMARTWEB



**AX-EC
WATER FAN HEATER**



*** AKN BOILER**



**FLEXIBLE METAL HOSES KIT
C07211 OR C07212 CODES**



**SMARTEASY
OR
SMARTWEB**

*** FOR COMBINATION WITH AKN, TAKE FLEXIBLE METAL HOSES FOR BOILER CONNECTION + FAN HEATER**

AX / TECHNICAL DATA

Model	Max air flow rate	Air throw distance	Sound pressure (5m)*	Heating heat output **	Cooling heat output ***	Power supply	Max water temperature	Max running pressure	Weight
	(m ³ /h)	m	dB(A)	kW	kW	V/Hz	°C	bar	kg
AX020	2,590	25	51.2	10.2	4.4	230V/1/50Hz	105	16	20
AX025	6,150	25	52.2	16.3	5.8	230V/1/50Hz	105	16	22
AX030	2,390	25	50.9	17.6	9.0	230V/1/50Hz	105	16	21
AX040	5,100	25	55.7	27.9	10.7	230V/1/50Hz	105	16	24
AX050	4,710	25	55.5	36.7	13.4	230V/1/50Hz	105	16	26
AX070	8,600	25	63.3	51.6	21.9	230V/1/50Hz	105	16	38
AX090	8,000	25	63.2	66.9	27.9	230V/1/50Hz	105	16	40

* Sound level in typical installation at 5 m

** Data measured under the following conditions: Δt of water 70/50°C ambient air temperature +15°C 50% R.U.

*** Data measured under the following conditions: Δt of water 7/12°C ambient air temperature 30°C 50% R.U. - Air flow rate (speed 2)

AX SERIES AND AX-EC SERIES / DIMENSIONS

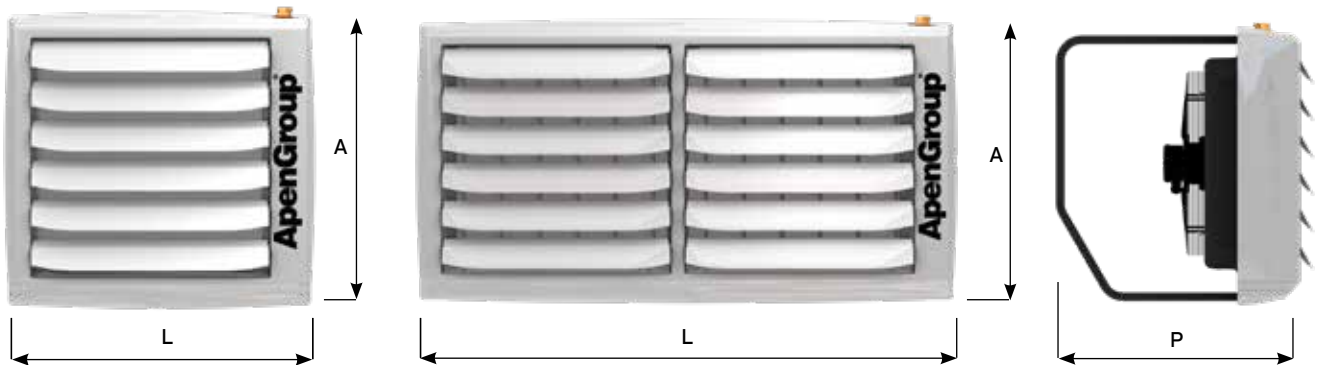

Model	Width mm	Height mm	Depth mm
AX020 - AX020EC	765	730	595
AX025 - AX025EC	765	730	595
AX030 - AX030EC	765	730	595
AX040 - AX040EC	765	730	595
AX050 - AX050EC	765	730	595
AX070 - AX070EC	1390	730	595
AX090 - AX090EC	1390	730	595

AX-EC / TECHNICAL DATA

Model	Rated heating performance				Rated cooling performance			Weight Kg
	Max air flow rate	Heat output max*	Water heat drop	Water flow rate	Max air flow rate	Max** heat output	Water heat drop	
	m ³ /h	kW	°C	l/h	m ³ /h	kW	°C	
AX020EC	2850	17.0	80-60	750	2530	4.2	7-12	22
AX025EC	4500	22.5	80-60	990	2360	4	7-12	24
AX030EC	2550	23.9	80-60	1050	2550	9.4	7-12	23
AX040EC	4350	34.1	80-60	1500	2330	8.9	7-12	26
AX050EC	3900	42.4	80-60	1870	2440	12.2	7-12	28
AX070EC	8560	68.9	80-60	3040	5550	20.7	7-12	40
AX090EC	7950	86.8	80-60	3830	4985	25.2	7-12	42

* Air temperature 15°C and relative humidity 50%

** Air temperature 27°C and relative humidity 50%

AX SERIES AND AX-EC SERIES / DIMENSIONS

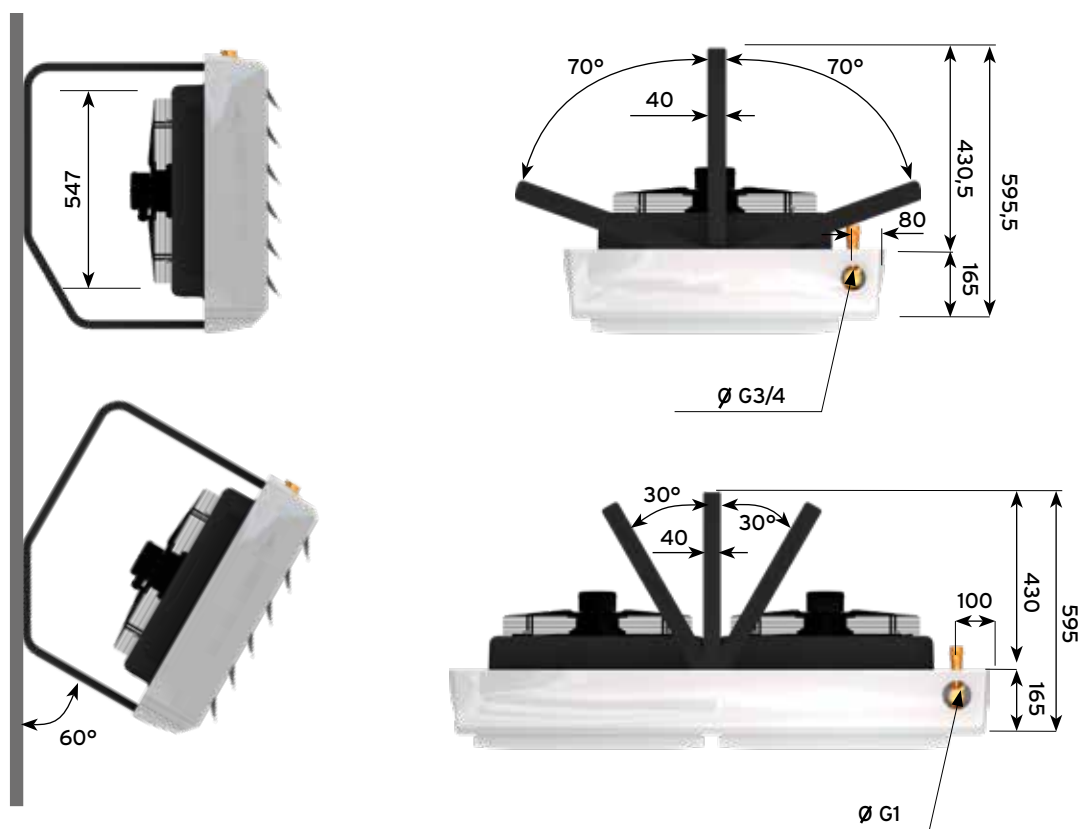

COMBINATIONS OF AKN BOILERS WITH AX-EC SERIES WATER FAN HEATERS



AKN034



AX050EC



AKN034



AX030EC



AX030EC



AKN050

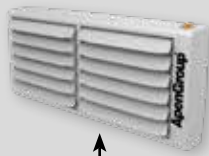

AX070EC



AKN050



AX040EC



AX040EC



AKN050



AX030EC



AX030EC



AX030EC



AKN070



AX090EC



AKN070



AX050EC



AX050EC



AKN070



AX030EC



AX030EC



AX030EC



AKN070



AX030EC



AX030EC



AX030EC



AX030EC

COMBINATIONS OF AKN BOILERS WITH AX-EC SERIES WATER FAN HEATERS

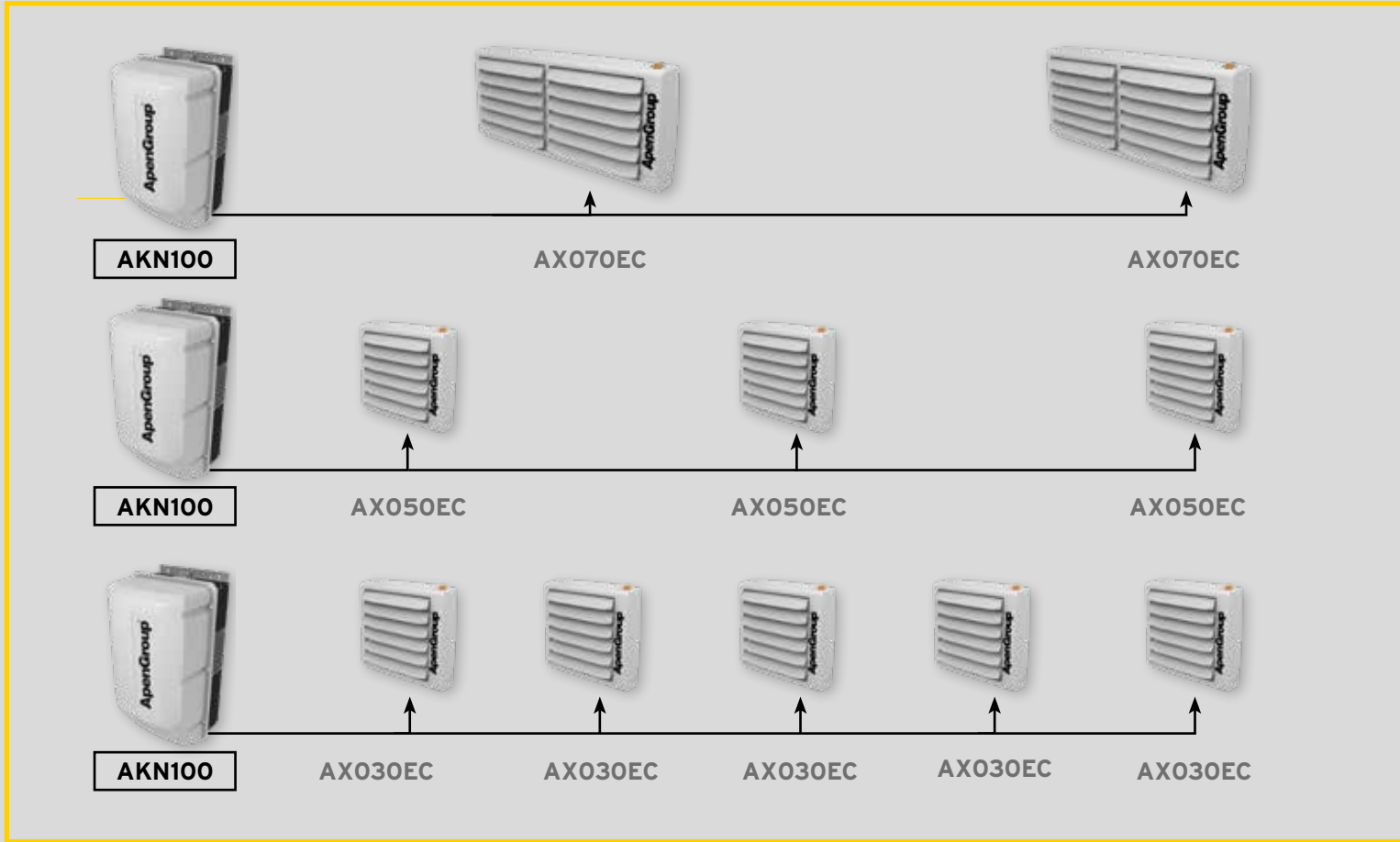



APEN GROUP S.p.A.
Via Isonzo, 1 - Pessano con Bornago
20042 (Milan) - Italy
Tel +39 02 95 96 931 Fax +39 02 95 74 27 58
www.apengroup.com apen@apengroup.com

Code X01330.01GB ed. 2206
The contents of this catalogue may be edited without prior notification.

